

# JVC



## COMPACT COMPONENT SYSTEM

SISTEMAS DE COMPONENTES COMPACTOS

SISTEMA DE COMPONENTES COMPACTOS

# MX-KB2

Consists of CA-MXKB2 and SP-MXKB2

Consiste de CA-MXKB2, y SP-MXKB2

Consiste em CA-MXKB2, e SP-MXKB2

# MX-KB1

Consists of CA-MXKB1 and SP-MXKB1

Consiste de CA-MXKB1, y SP-MXKB1

Consiste em CA-MXKB1, e SP-MXKB1

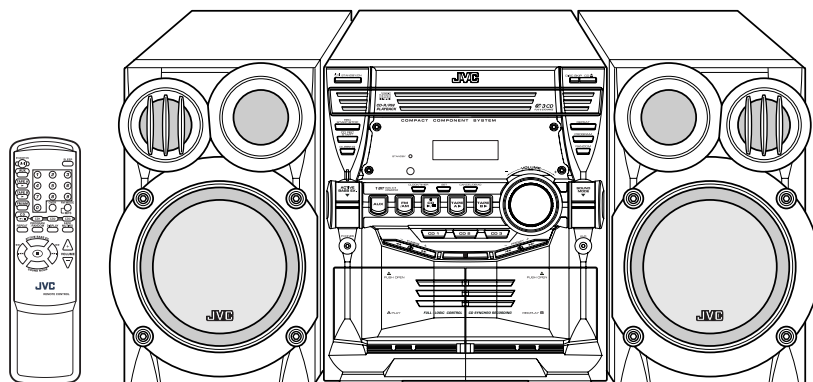

COMPACT  
**disc**  
DIGITAL AUDIO

**INSTRUCTIONS**  
MANUAL DE INSTRUCCIONES  
INSTRUÇÕES

LVT1251-007A  
[UW]

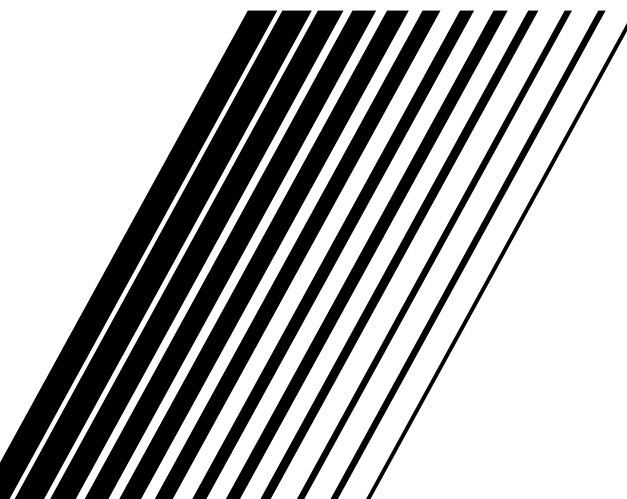

# Warnings, Cautions and Others

## Avisos, precauciones y otras notas

### Advertências, precauções e outras notas

#### CAUTION

To reduce the risk of electrical shocks, fire, etc.:

1. Do not remove screws, covers or cabinet.
2. Do not expose this appliance to rain or moisture.

#### PRECAUCIÓN

Para reducir riesgos de choques eléctricos, incendio, etc.:

1. No extraiga los tornillos, los cubiertas ni la caja.
2. No exponga este aparato a la lluvia o a la humedad.

#### PRECAUÇÃO

Para reduzir riscos de choques elétricos, incêndio, etc.:

1. Não remova parafusos e tampas ou desmonte a caixa.
2. Não exponha este aparelho à chuva nem à umidade.

#### CAUTION — $\phi$ /I STANDBY/ON button !

Disconnect the mains plug to shut the power off completely (all lamps and indications go off). The  $\phi$ /I STANDBY/ON button in any position does not disconnect the mains line.

- When the unit is on standby, the STANDBY lamp lights red.
- When the unit is turned on, the STANDBY lamp goes off.

The power can be remote controlled.

#### PRECAUCIÓN — Botón $\phi$ /I STANDBY/ON !

Desconecte el enchufe tomacorriente para desconectar la alimentación completamente (se apagan todas las lámparas e indicaciones). Ninguna posición del botón  $\phi$ /I STANDBY/ON conseguirá desconectar la red de alimentación eléctrica.

- Cuando la unidad está en espera, la lámpara STANDBY se enciende en rojo.
- Cuando la unidad está encendida, la lámpara STANDBY se apaga.

La alimentación puede controlarse mediante control remoto.

#### CUIDADO — botão $\phi$ /I STANDBY/ON !

Desligue a ficha da tomada da parede para desligar completamente a alimentação (todas as luzes e indicadores apagam-se). O botão  $\phi$ /I STANDBY/ON, quer esteja premido ou solto, não desliga a alimentação principal.

- Quando a unidade estiver em standby, a luz STANDBY fica vermelha.
- Quando a unidade estiver ligada, a luz STANDBY apaga-se.

A alimentação pode ser controlada à distância.

## IMPORTANT FOR LASER PRODUCTS / IMPORTANTE PARA PRODUCTOS LÁSER / IMPOTANTE PARA PRODUTOS LASER

### IMPORTANT FOR LASER PRODUCTS

1. CLASS 1 LASER PRODUCT
2. **CAUTION:** Do not open the top cover. There are no user serviceable parts inside the unit; leave all servicing to qualified service personnel.
3. **CAUTION:** Visible and invisible laser radiation when open and interlock failed or defeated. Avoid direct exposure to beam.
4. REPRODUCTION OF LABEL: CAUTION LABEL, PLACED INSIDE THE UNIT.

### PARA PRODUTOS LASER, IMPORTANTE

1. PRODUTO LASER DE CLASSE 1
2. **PRECAUÇÃO:** não abrir a cobertura superior. Dentro da unidade não existem partes cuja manutenção tenha de ser feita pelo usuário; deixe qualquer manutenção a cargo do pessoal de serviço qualificado.
3. **PRECAUÇÃO:** radiação laser visível e invisível quando se abre e com a conexão interna em falha ou frustrada. Evite a exposição direta ao raio.
4. REPRODUÇÃO DE ETIQUETA: ETIQUETA DE AVISO SITUADA NO INTERIOR DA UNIDADE.

### IMPORTANTE PARA PRODUCTOS LÁSER

1. PRODUCTO LASER CLASE 1
2. **PRECAUCIÓN:** No abra la tapa superior. En el interior de la unidad no hay piezas que pueda reparar el usuario; encargue el servicio a personal técnico cualificado.
3. **PRECAUCIÓN:** Radiación láser visible e invisible en caso de apertura o con interbloqueo averiado o defectuoso. Evite la exposición directa a los haces.
4. REPRODUCCIÓN DE LA ETIQUETA: ETIQUETA DE PRECAUCIÓN, COLOCADA EN EL INTERIOR DE LA UNIDAD.

<b>CAUTION</b> : Visible and invisible laser radiation when open and interlock failed or defeated. AVOID DIRECT EXPOSURE TO BEAM.	<b>ADVARSEL</b> : Synlig og usynlig laserstråling når maskinen er åben eller interlocken fejler. Undgå direkte eksponering til stråling.	<b>VARNING</b> : Synlig och osynlig laserstråling när den öppnas och spärren är urkopplad. Betrakta ej strålen.	<b>VARO</b> : Avattaessa ja suojalukitus ohitettuna tai viallisena olet alltiina näkyvälle ja näkymättömälle lasersäteilylle. Vältä säleen kohdistumista suoraan itseesi. (f)
---	--	---	---

**Caution: Proper Ventilation**

To avoid risk of electric shock and fire, and to prevent damage, locate the apparatus as follows:

- 1 Front: No obstructions and open spacing.
- 2 Sides/ Top/ Back: No obstructions should be placed in the areas shown by the dimensions below.
- 3 Bottom: Place on the level surface. Maintain an adequate air path for ventilation by placing on a stand with a height of 10 cm or more.

**Precaución: el aparato debe estar bien ventilado**

Para evitar posibles riesgos de descargas eléctricas e incendios y prevenir cualquier posible daño, coloque el aparato del modo siguiente:

- 1 Parte delantera: No ponga nada delante, deje el espacio libre.
- 2 Laterales/ parte superior/ parte trasera: No se debería colocar nada en las áreas y las distancias que se detallan a continuación.
- 3 Parte inferior: Coloque el aparato sobre una superficie recta. Debe haber buena circulación de aire; para ello, coloque el aparato sobre una base a una altura mínima de 10 cm.

**Precaução: Ventilação adequada**

Para evitar riscos de choques elétricos e incêndios, e prevenir avarias, instale o aparelho como segue:

- 1 Parte frontal: Sem obstruções e espaços abertos.
- 2 Partes laterais/ tampa/ posterior: Nenhuma obstrução deverá ser colocada entre as áreas cujas dimensões são indicadas abaixo.
- 3 Parte inferior: Instale-o sobre uma superfície plana. Deverá ser mantido espaço suficiente para a ventilação se este for instalado numa posição que tenha uma altura de 10 cm ou mais.

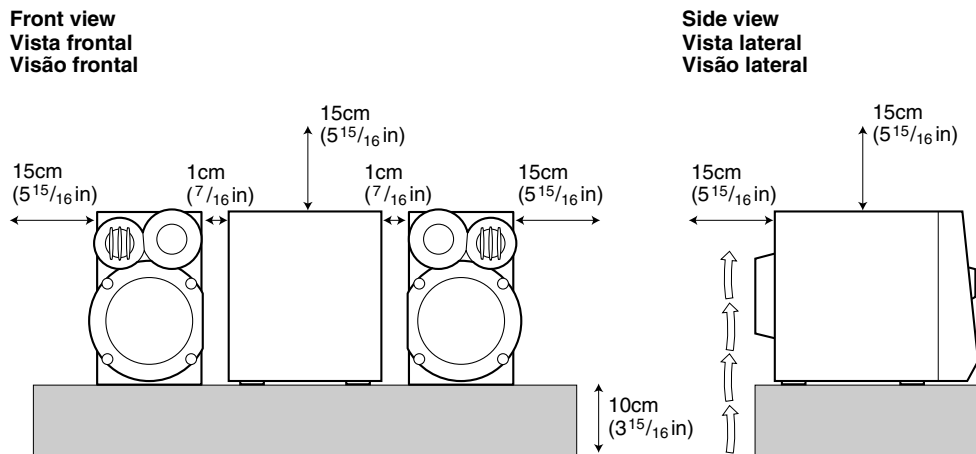
**CAUTION**

1. Do not block the ventilation openings or holes. (If the ventilation openings or holes are blocked by a newspaper or cloth, etc., the heat may not be able to get out.)
2. Do not place any naked flame sources, such as lighted candles, on the apparatus.
3. When discarding batteries, environmental problems must be considered and local rules or laws governing the disposal of these batteries must be followed strictly.
4. Do not expose this apparatus to rain, moisture, dripping or splashing and that no objects filled with liquids, such as vases, shall be placed on the apparatus.

**PRECAUCION!**

1. No obstruya las rendijas o los orificios de ventilación. (Si las rendijas o los orificios de ventilación quedan tapados con un periódico, un trozo de tela, etc., no se podrá disipar el calor).
2. No ponga sobre el aparato ninguna llama al descubierto, como velas encendidas.
3. Cuando tenga que descartar las pilas, tenga en cuenta los problemas ambientales y observe estrictamente los reglamentos o las leyes locales sobre disposición de las pilas.
4. No exponga este aparato a la lluvia, humedad, goteos o salpicaduras. Tampoco ponga recipientes conteniendo líquidos, como floreros, encima del aparato.

**CUIDADO**

1. Não tape as aberturas ou os orifícios de ventilação. (Se tapar as aberturas ou orifícios de ventilação com um jornal, um pano, etc., o calor não sai).
2. Não coloque objectos com chama, como velas acesas, em cima do aparelho.
3. Quando se desfizer das baterias, deve ter em consideração os problemas ambientais e respeitar integralmente os regulamentos e leis locais relativos à forma de deitar fora as baterias.
4. N'exposez pas cet appareil à la pluie, à l'humidité, à un àngouttement ou à des àmclaboussures et ne placez pas des objets remplis de liquide, tels qu'un vase, sur l'appareil.

# Introduction

Thank you for purchasing the JVC Compact Component System. We hope it will be a valued addition to your home, giving you years of enjoyment. Be sure to read this instruction manual carefully before operating your new stereo system. In it you will find all the information you need to set up and use the system. If you have a query that is not answered by the manual, please contact your dealer.

## Features

Here are some of the things that make your System both powerful and simple to use.

- The controls and operations have been redesigned to make them very easy to use, freeing you to just enjoy the music.
  - With JVC's COMPU PLAY you can turn on the System and automatically start the Radio, Cassette Deck, or CD Player with a single touch.
- The great SEA (Sound Effect Amplifier) effects Rock, Pop and Classics are provided.
- The Active Bass EX. (Extension) circuitry faithfully reproduces low frequency sounds.
- A 20-station preset capability (10 FM and 10 AM) in addition to auto-seek and manual tuning.
- CD changer function can operate 3 discs.
  - Discs can be changed during play using the Carrousel tray (rotational tray).
  - Continuous or program play of 3 discs.
- Two Decks enabling tape dubbing.
- Timer functions; Daily Timer, REC (Recording) Timer, and Sleep Timer.
- You can connect various external units, such as an MD recorder.
- The CD Player can play back a CD-R and CD-RW.



## How This Manual Is Organized

- Basic information that is the same for many different functions - e.g. setting the volume - is given in the section "Basic Operations", and not repeated under each function.
- The names of buttons/controls and display messages are written in all capital letters: e.g. FM/AM, "NO DISC".
- If the button names on the Unit and the Remote Control are the same, the description on where the button is used will be omitted.
- System functions are written with an initial capital letter only: e.g. Normal Play.

Use the table of contents to look up specific information you require.

We have enjoyed making this manual for you, and hope it serves you in enjoying the many features built into your System.

## IMPORTANT CAUTIONS

### 1 Installation of the System

- Select a place which is level, dry and neither too hot nor too cold. (Between 5°C and 35°C or 41°F and 95°F.)
- Leave sufficient distance between the System and a TV.
- Do not use the System in a place subject to vibrations.

### 2 Power cord

- Do not handle the power cord with wet hands!
- Some power is always consumed as long as the power cord is connected to the wall outlet.
- When unplugging the System from the wall outlet, always pull the plug, not the power cord.

### 3 Malfunctions, etc.

- There are no user serviceable parts inside. In case of system failure, unplug the power cord and consult your dealer.
- Do not insert any metallic object into the System.

# Table of Contents

<b>Introduction .....</b>	<b>1</b>
Features.....	1
How This Manual Is Organized.....	1
IMPORTANT CAUTIONS.....	1
<b>Table of Contents .....</b>	<b>2</b>
<b>Getting Started .....</b>	<b>3</b>
Accessories .....	3
Set the VOLTAGE SELECTOR Switch.....	3
How To Put Batteries In the Remote Control.....	3
Using the Remote Control .....	4
Connecting the FM Antenna.....	4
Connecting the AM Antenna.....	5
Connecting the Speakers .....	5
Connecting External Equipment.....	6
Connecting to the Wall Outlet.....	6
DEMO Mode .....	6
COMPU Play.....	6
<b>Basic Operations.....</b>	<b>7</b>
Turning the Power On and Off .....	7
Adjusting the Volume.....	7
Fade-out Muting (FADE MUTING) .....	8
Reinforcing the Bass Sound (ACTIVE BASS EX.).....	8
Selecting the Sound Mode (SOUND MODE).....	8
Entering the Number with the Remote Control (Numeric Keys).....	8
Changing the Display .....	8
<b>Using the Tuner .....</b>	<b>9</b>
Tuning In a Station .....	9
Presetting Stations .....	10
To Change the FM Reception Mode .....	10
<b>Using the CD Player .....</b>	<b>11</b>
To Load CDs .....	12
To Unload CDs.....	12
Changing the MP3 Playback Mode (for MX-KB2 only) .....	12
Basics of Using the CD Player-Normal Play.....	13
Programming the Playing Order of the Tracks.....	14
Random Play.....	15
Repeating Tracks .....	15
Tray Lock Function .....	15
Changing the Display for CD .....	15
<b>Using the Cassette Deck (Listening to a Tape) .....</b>	<b>16</b>
Playing a Tape .....	16
<b>Using the Cassette Deck (Recording) .....</b>	<b>17</b>
Standard Recording .....	18
CD Synchro Recording.....	18
Tape to Tape Recording (DUBBING).....	18
<b>Using an External Equipment .....</b>	<b>19</b>
Listening to the External Equipment.....	19
<b>Using the Timers .....</b>	<b>20</b>
Setting the Clock .....	20
Fixing the Clock .....	20
Setting the Daily Timer .....	21
Setting the REC (Recording) Timer .....	22
Setting the SLEEP Timer .....	24
Timer Priority .....	24
<b>Care And Maintenance.....</b>	<b>25</b>
<b>Troubleshooting .....</b>	<b>26</b>
<b>Specification .....</b>	<b>26</b>

# Getting Started

## Accessories

Make sure that you have all of the following items, which are supplied with the System.

- AM Loop Antenna (1)
- FM Wire Antenna (1)
- Remote Control (1)
- Batteries (2)
- AC Plug Adaptor (1)

If any of these items are missing, contact your dealer immediately.

## Set the **VOLTAGE SELECTOR** Switch

To avoid damaging the System, set the voltage before plugging in the System.

Set the correct voltage for your area with the **VOLTAGE SELECTOR** switch on the back of the Unit. Use a screwdriver to rotate the selector so the displayed voltage is the same as the voltage.

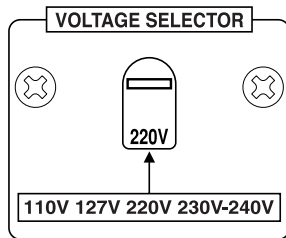

### **CAUTION:**

- Make all connections before plugging the System into an AC power outlet.

## How To Put Batteries In the Remote Control

Match the polarity (+ and -) on the batteries with the + and - markings in the battery compartment.

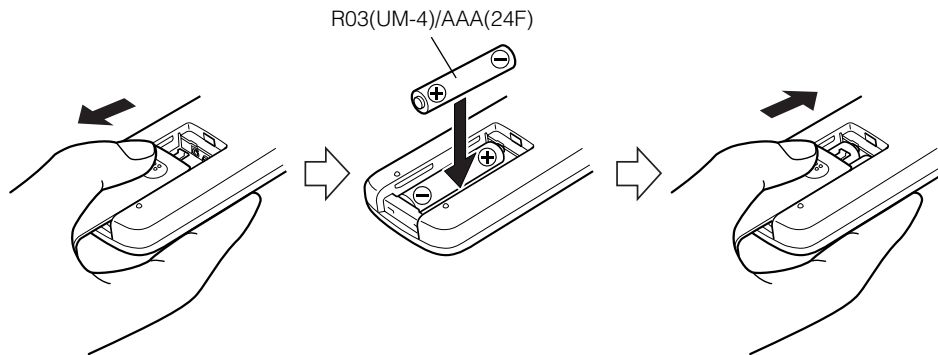

### **CAUTION:**

- Handle batteries properly.

☐ To avoid battery leakage or explosion:

- Remove batteries when the Remote Control will not be used for a long time.
- When you need to replace the batteries, replace both batteries at the same time with new ones.
- Do not use an old battery with a new one.
- Do not use different types of batteries together.

## Using the Remote Control

The Remote Control makes it easy to use many of the functions of the System from a distance of up to 7m away. You need to point the Remote Control at the remote sensor on the System's front panel.

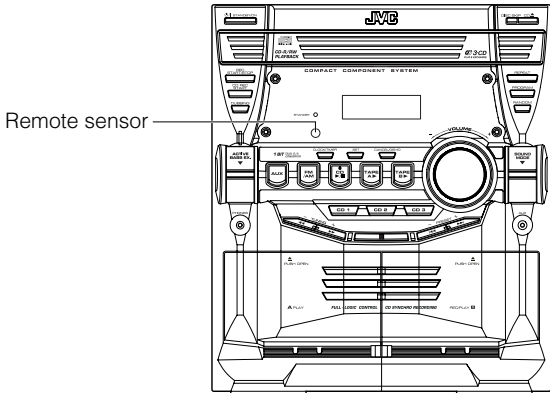

### **CAUTION:**

- Make all connections before plugging the System into an AC power outlet.

## Connecting the FM Antenna

### Using the Supplied Wire Antenna

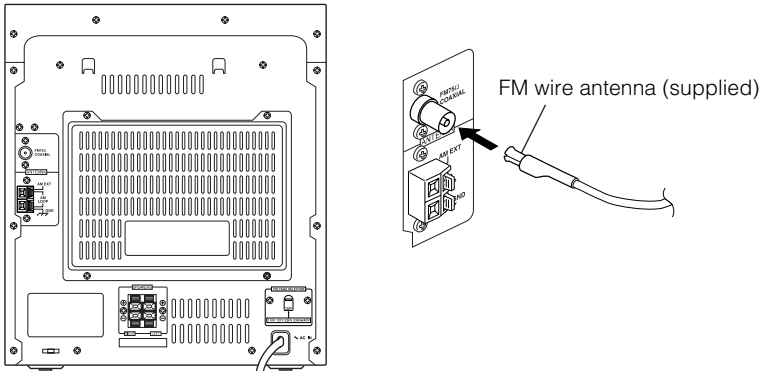

### Using the Coaxial Type Connector (Not supplied)

A 75-ohm antenna with coaxial type connector (IEC or DIN45 325) should be connected to the FM 75-ohm COAXIAL terminal.

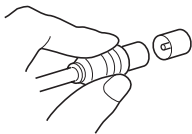

If reception is poor, connect the outdoor antenna.

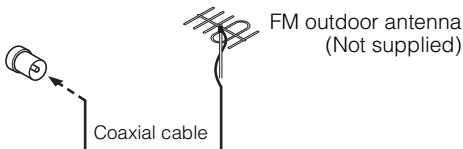

### Note

- Before attaching a 75 ohm coaxial lead (the kind with a round wire going to an outdoor antenna), disconnect the supplied FM Wire Antenna.

## Getting Started

## Connecting the AM Antenna

### Rear Panel of the Unit

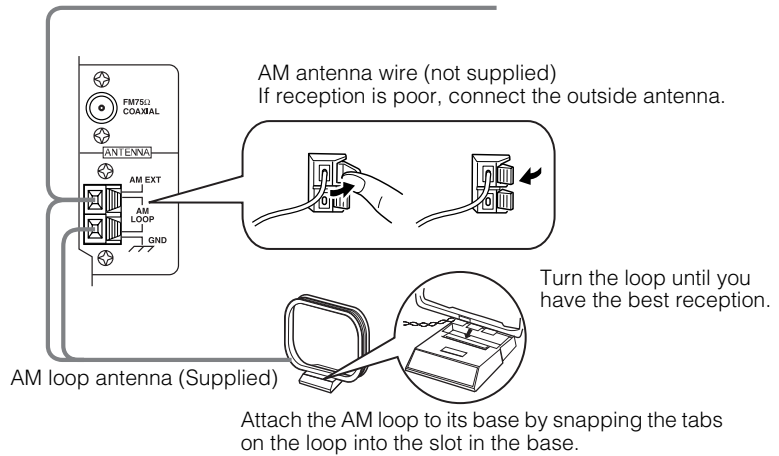
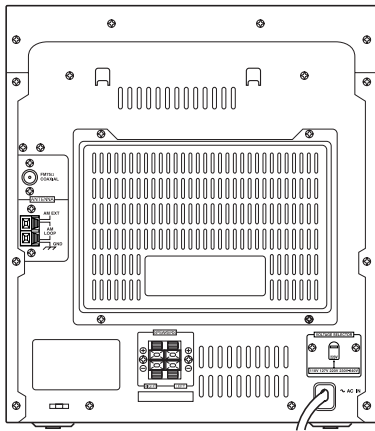

- Even when connecting an outside AM antenna, keep the indoor AM loop connected.

### CAUTION:

- To avoid noise, keep antennas away from the System, the connecting cord and the AC power cord.

## Connecting the Speakers

Connect the right speaker to the RIGHT speaker terminals and the left speaker to the LEFT speaker terminals. “Right” / “Left” is labeled on the rear of the speaker.

1. Open each of the terminals to connect the speaker wire leads.
2. Connect the speaker cords to the Speaker terminals of the Unit.  
Connect the red (+) and black (-) cords of the right side speaker to the red (+) and black (-) terminals marked RIGHT on the System.  
Connect the red (+) and black (-) cords of the left side speaker to the red (+) and black (-) terminals marked LEFT on the System.
3. Close each of the terminals.

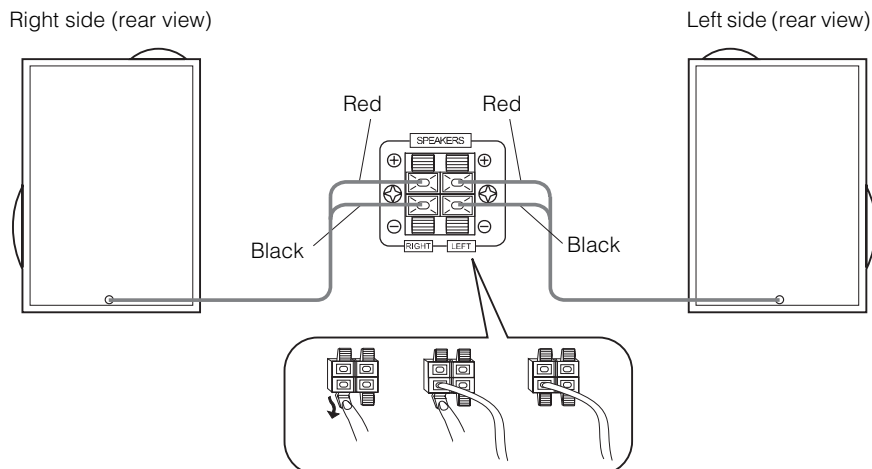

### CAUTIONS:

- A TV may display irregular colors if located near the speakers. If this happens, set the speakers away from the TV.
- Use speakers with the correct impedance only. The correct impedance is indicated on the rear panel.



## Connecting External Equipment

Connect a signal cord with stereo mini plugs (not supplied) between the System's AUX jack on the front panel and the audio output jack or output terminals of the external portable CD, MD player, STB, etc. You can then listen to the external source through the System.

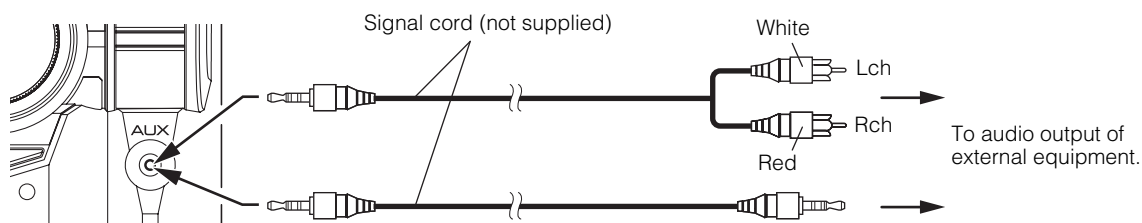

## Connecting to the Wall Outlet

Plug the AC power cord into the wall outlet. Now, your System is at your command!

## DEMO Mode

When the System is connected to the wall outlet, a DEMO mode displaying some of the system's features automatically starts.

**To turn the DEMO display off**, press any of the operation buttons. The DEMO display automatically stops.

**To turn the DEMO display on**, press the DEMO button on the Unit.



### Note

- While the System is turned on, the DEMO display will automatically start if no operation is made for 2 minutes. To cancel this auto DEMO display function, press the CANCEL button on the Unit during DEMO display.

## COMPU Play

JVC's COMPU PLAY feature lets you control the most frequently used System functions with a single touch.

With One Touch Operation you can play a CD, a tape, turn on the radio, or listen to an external equipment with a single press of the play button for that function. One Touch Operation turns the power on for you, then starts the function you have specified. If the System is not ready (no CD or tape in place), the System still powers on so you can insert a CD or tape.

How One Touch Operation works in each case is explained in the section dealing with that function.

The COMPU PLAY buttons are:

### On the Unit

- CD ►/|| button
- FM/AM button
- TAPE A ►, TAPE B ► buttons
- AUX button
- CD1, CD2 and CD 3 buttons

### On the Remote Control

- CD ►/|| button
- FM/AM button
- TAPE A ►, TAPE B ► buttons
- AUX button
- CD1, CD2 and CD 3 buttons

# Basic Operations

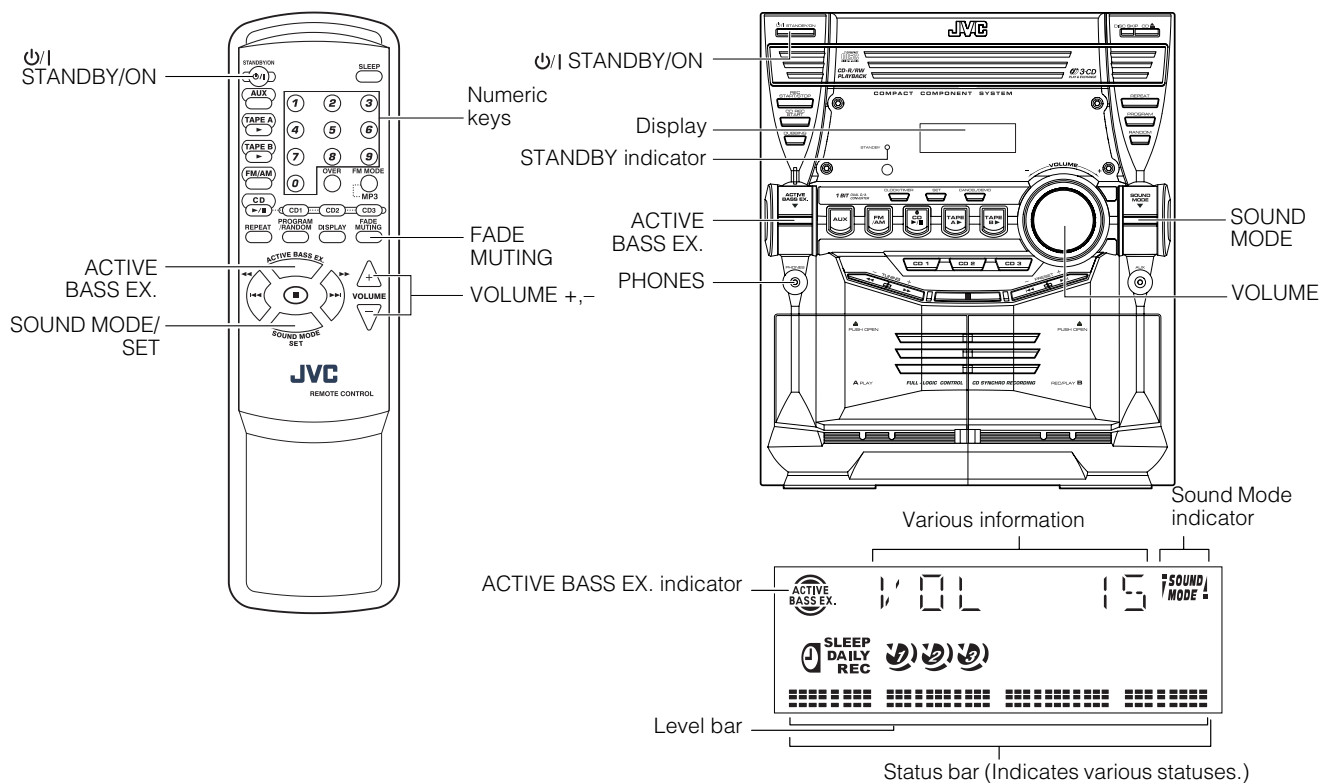

\* When the System is in use, the display shows other items as well. For simplicity, we show here only the items described in this section.

## Turning the Power On and Off

### Turning the System On

#### 1 Press the **STANDBY/ON** button.

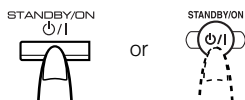

The display comes on. The STANDBY indicator goes out. The System comes on ready to continue in the mode it was in when the power was last turned off.

- For example, if the last thing you were doing was listening to a CD, you are now ready to listen to a CD again. If you wish, you can change to another source.
- If you were listening to the Tuner last, the Tuner comes on playing the station it was last set to.

### Turning the System Off

#### 1 Press the **STANDBY/ON** button again.

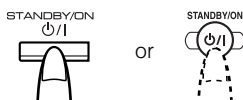

The display goes out, except for the clock display. The STANDBY indicator lights up. (The display is dimmed.)

- Some power is always consumed even though power is turned off (called Standby mode).
- To switch off the System completely, unplug the AC power cord from the wall outlet. When you unplug the AC power cord, the clock will be reset to 0:00 immediately.

## Adjusting the Volume

Turn the VOLUME control on the Unit clockwise to increase the volume or turn it counterclockwise to decrease the volume. Press the VOLUME + button on the Remote Control to increase the volume or press the VOLUME - button on the Remote Control to decrease the volume.

VOL 15

You can set the volume level to MIN, 1-30, or MAX.

### **CAUTION:**

- **DO NOT** turn on the System and/or start playing any source without first setting the VOLUME control to minimum, as a sudden blast of sound could damage your hearing, speakers and/or headphones.

### For private listening

Connect a pair of headphones to the PHONES jack. No sound comes out of the speakers.

Be sure to turn down the volume before connecting or putting on headphones.

## Fade-out Muting (FADE MUTING)

You can mute the output with one touch operation.

**To muting the output**, press the FADE MUTING button on the Remote Control. The output is faded out.

**To release muting**, press the FADE MUTING button once again. The output is faded in to the previous level.

- After Fade-out Muting, turning the VOLUME control on the unit or pressing the VOLUME button on the Remote Control will increase the volume from MIN. setting.

## Reinforcing the Bass Sound (ACTIVE BASS EX.)

The richness and fullness of the bass sound is maintained regardless of how low you set the volume.

You can use this effect only for playback.

**To get the effect**, press the ACTIVE BASS EX. (Extension) button.

The “ACTIVE BASS EX.” indicator lights up and “BASS ON” appears on the display.

**To cancel the effect**, press the button again.

The “ACTIVE BASS EX.” indicator goes out and “BASS OFF” appears on the display.

## Selecting the Sound Mode (SOUND MODE)

You can select one of 3 SEA (Sound Effect Amplifier) modes.

You can use this effect only for playback.

**To get the effect**, press the SOUND MODE button until Sound Mode you want appears on the display.

The “SOUND MODE” indicator lights up in the display.

Each time you press the button, the Sound Mode changes as follows:

ROCK → POP → CLASSIC → FLAT → (back to the beginning)

**To cancel the effect**, press the SOUND MODE button until “FLAT” appears on the display.

The “SOUND MODE” indicator goes off.

<b>ROCK</b>	Boosts low and high frequencies. Good for acoustic music.
<b>POP</b>	Good for vocal music.
<b>CLASSIC</b>	Set for wide and dynamic sound stereo systems.
<b>FLAT</b>	No sound effect applies.

## Entering the Number with the Remote Control (Numeric Keys)

You will use the number keys on the Remote Control to enter numbers for presetting stations, recalling the preset stations, or programming the playing tracks on CDs.

How to enter the number with the number keys is explained here.

### Examples:

- To enter number 5, press 5.
- To enter number 15, press OVER, 1, then 5.
- To enter number 20, press OVER, 2, then 0.

### For MP3 (For MX-KB2 only)

- To enter number 5, press 5.
- To enter number 15, press OVER, 0, 1, then 5.
- To enter number 125, press OVER, 1, 2, then 5.

## Changing the Display

Each time you press the DISPLAY button, the display changes as shown below:

Currently selected source ↔ Current time

### For CD

For CD, see “Changing the Display for CD” on page 15.

# Using the Tuner

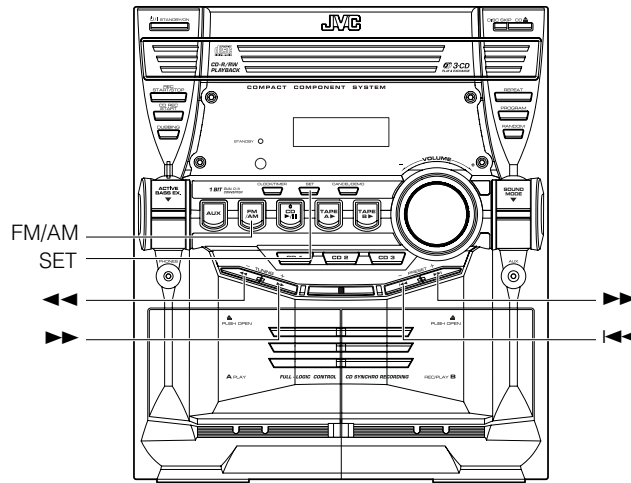
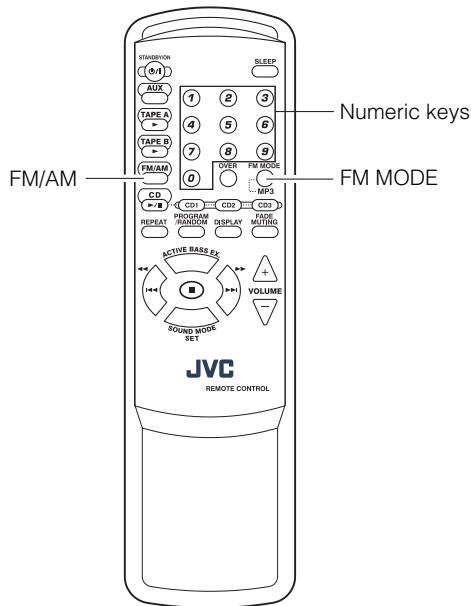

Band display, Frequency display, Preset number

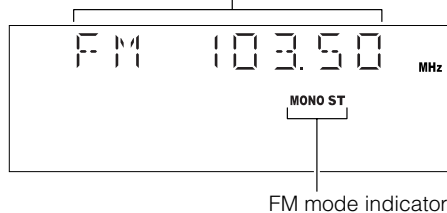

FM mode indicators

\* When the System is in use, the display shows other items as well.  
For simplicity, we show here only the items described in this section.

You can listen to FM and AM stations. Stations can be tuned in manually, automatically, or from preset memory storage.

☐ Before listening to the radio:

- Make sure that both the FM and AM antennas are correctly connected. (See page 4 and 5).

## Setting the Tuner Interval Spacing

When shipped, the FM tuner interval is set to 100kHz spacing and the AM tuner interval is set to 10kHz spacing. You can change the FM or AM tuner interval spacing individually.

### Changing the FM tuner interval spacing

When the system is in the FM mode, each time you hold down the **■** button and press the SOUND MODE button, the "FM 50kHz" and "FM 100kHz" appears on the display alternately and the FM tuner interval spacing is switched.

### Changing the AM tuner interval spacing

When the system is in the AM mode, each time you hold down the **■** button and press the SOUND MODE button, the "AM 9kHz" and "AM 10kHz" appears on the display alternately and the AM tuner interval spacing is switched.

## One Touch Radio

Just press the FM/AM button to turn on the System and start playing the station you were last tuned to.

- ☐ You can switch from any other sound source to the radio by pressing the FM/AM button.

## Tuning In a Station

### 1 Press the FM/AM button.

The Band and Frequency you were last tuned to appear on the display.

(If the last station was selected using the preset number, the preset number and frequency appear.)

Each time you press the button, the band alternates between FM and AM.

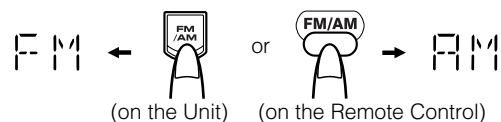

## 2 Select a station using one of the following methods.

### • Manual Tuning

Briefly press the ◀◀ or ▶▶ button to move from frequency to frequency until you find the station you want.

OR

### • Auto Tuning

If you hold down the ◀◀ or ▶▶ button for 1 second or more and then release it, the frequency changes down, or up, automatically until a station is found.

OR

### • Preset Tuning (Possible only after presetting stations)

#### Preset tuning using the Unit:

Select the preset number you want, using the ◀◀ or ▶▶ button.

#### Example:

Press the ▶▶ button until the preset number "8" appears on the display. The display will show the preset number and frequency.



#### Preset tuning using the Remote Control:

Enter the preset number you want to recall using the numeric keys. See "Entering the Number with the Remote Control" on page 8.

#### Example:

Press 8 to recall the preset number 8. Then, the display will show the preset number and frequency.



- In AM broadcast, reception sensitivity will be changed by turning the AM loop antenna. Turn the AM loop antenna for best reception.

## Presetting Stations

You can preset up to 10 FM stations and up to 10 AM stations.



- Preset numbers may have been set to factory test frequencies prior to shipment. This is not a malfunction. You can preset the stations you want into memory by following one of the presetting methods below.
- During presetting stations, if no button operation is made for 4 seconds, the display returns to the band/frequency display. In this case, repeat steps from the beginning.

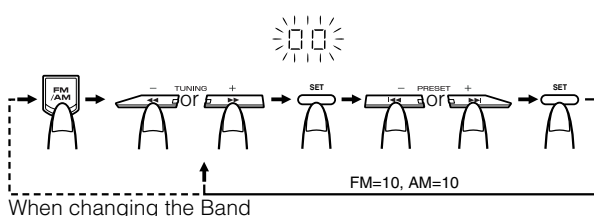

## Using the Unit

**1** Select a band by pressing the FM/AM button.

**2** Press the ◀◀ or ▶▶ button to tune in a station.

**3** Press the SET button.

"00" will blink for 4 seconds.

**4** Press the ◀◀ or ▶▶ button to select the preset number.

▶▶: Increases the preset number by 1.

◀◀: Decreases the preset number by 1.

**5** Press the SET button.

The display shows the stored preset number and frequency.

**6** Repeat above steps 2 to 5 for each station you want to store in memory with a preset number.

To change the preset stations, repeat the same steps as above.



- In step 4, you can select the preset number using the numeric keys on the Remote Control. See "Entering the Number with the Remote Control" on page 8.

## CAUTION:

- Even if the System is unplugged or if the power failure occurs, the preset stations will be stored for a few days. However, in case the preset stations are erased, you will need to preset the stations again.

## To Change the FM Reception Mode

When you are tuned in to an FM stereo broadcast, the "ST (Stereo)" indicator lights up and you can hear stereo effects.

If an FM stereo broadcast is hard to receive or noisy, you can select Monaural mode. Reception improves, but you lose stereo effect.

Press the FM MODE button on the Remote Control so that the "MONO" indicator lights up on the display.

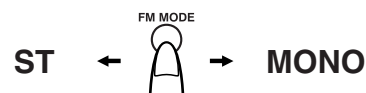

To restore the stereo effect, press the FM MODE button on the Remote Control so that the "MONO" indicator goes off.

Selecting other station will also cancel the FM Mono mode and restore the stereo effect.

# Using the CD Player

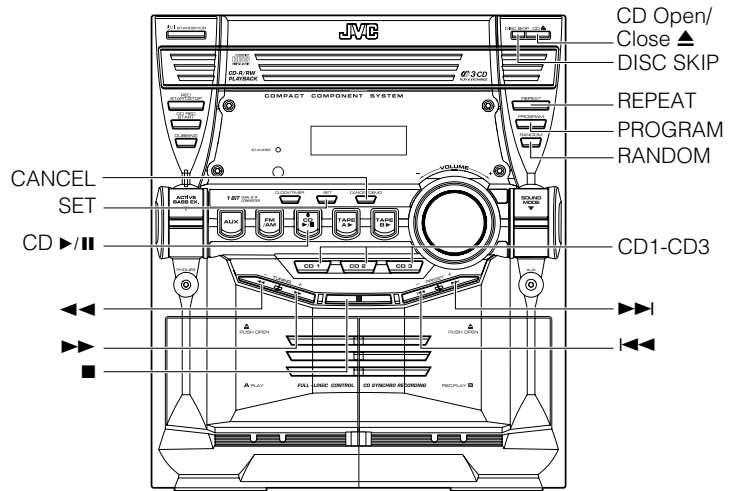
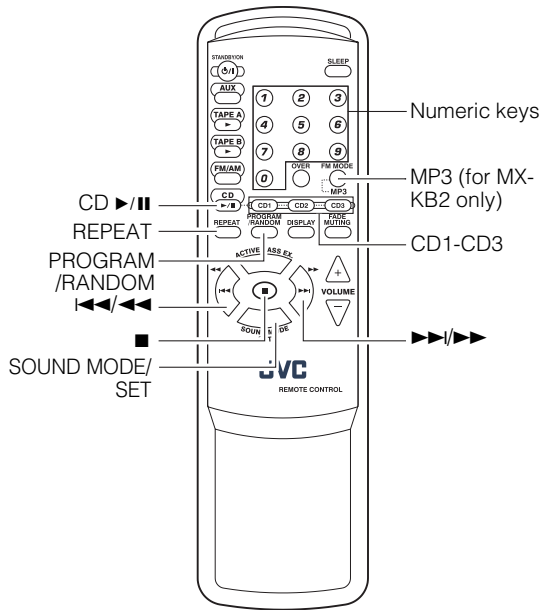

Track number, Playing time, Program number, etc.

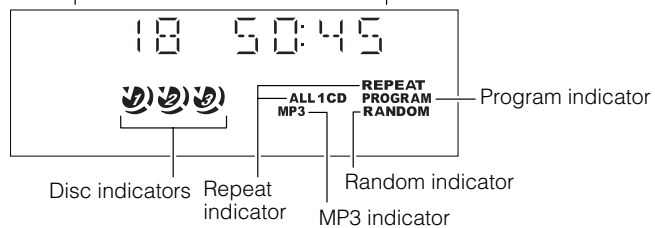

\* When the System is in use, the display shows other items as well.  
For simplicity, we show here only the items described in this section.

This unit has been designed to playback the following CDs:

- Audio CD
- CD-R (CD-Recordable)
- CD-RW (CD-ReWritable)

### For MX-KB2 only

- MP3 disc (MP3 files recorded on a CD-R or CD-RW)\*

### When playing a CD-R or CD-RW

- User-edited CD-Rs (CD-Recordable) and CD-RWs (CD-ReWritable) can be played back when they are already “finalized.”
- Before playing back CD-Rs or CD-RWs, read their instructions or cautions carefully.
- Some CD-Rs or CD-RWs may not be played back on this unit because of their disc characteristics, damage or stain on them, or if the player’s lens is dirty.
- CD-RWs may require a longer readout time since the reflectance of CD-RWs is lower than for regular CDs.

### For MX-KB2 only

#### \*For MP3 discs

- This unit manages files and folders on MP3 discs as “tracks” and “albums.”
- Playback order of the MP3 files (tracks) recorded on a disc are determined by the writing (or encoding) application; therefore, playback order may be different from the one you have intended while recording the files and the folders.
- This unit shows the file (track) names and ID3v1 tags (only “Title”, “Artist” and “Album”) on the display after starts play; however, there is a limitation on available characters and some file names and ID3 tags are not shown correctly.

### Notes

#### More about MP3 discs

- MP3 discs (either CD-R or CD-RW) require a longer readout time. (It varies due to the complexity of the recording configuration.)
- When making an MP3 disc, select ISO 9660 Level 1 or Level 2 as the disc format.
- This unit does not support multisession recording.
- This unit can play MP3 files only with the following file extensions— “.MP3,” “.Mp3,” “.mp3,” and “.mp3.”
- Non-MP3 files are ignored. If non-MP3 files are recorded together with MP3 files, this unit will take a longer time to scan the disc. It may also cause the unit to malfunction.
- Non-MP3 folders are counted when reading disc, but ignored during playing back.
- Some MP3 discs may not be played back because of their disc characteristics or recorded conditions.

## About Disc Indicator:

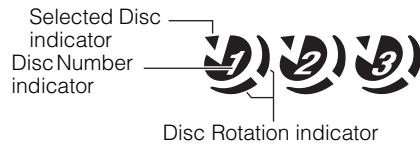

The Disc indicator consists of the following three kinds of indicators:

**Disc Number indicator:** Lights all the time.

**Selected Disc indicator:** Lights for the currently selected disc number.

**Disc Rotation indicator:** Runs when the selected CD is playing or paused. This indicator goes out if a CD is not loaded for the selected disc number.

## One Touch Play

The power comes on, and operations are done automatically.

- By pressing the CD ►/|| button, the System will come on, and if a CD is loaded for the disc number that was lastly selected, it will start playing from the first track.
- By pressing the CD1-CD3 button, the System will come on, and if a CD is already loaded for the selected disc number, it will start play from the first track.

## To Load CDs

**1 Press the CD Open/Close ▲ button on the Unit to open the tray.**

**2 Place one or two CDs, with its label side up, onto the tray.**

Be sure that the CD is securely seated inside the recess on the disc tray.

With the label side up

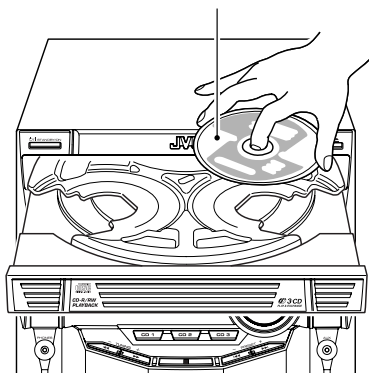

**3 Press the DISC SKIP button on the Unit and place the next CD.**

When you press the button, the tray turns for the next CD.

**4 Press the CD Open/Close ▲ button on the Unit.**

The tray is closed.

- When you use an 8 cm CD, place it on the inner circle of the tray.
- You can load CDs while listening to the other source or while listening to the CD being played back.
- When power is turned off with the tray opened, the tray is automatically closed.
- If the CD cannot be read correctly (because it is scratched, for example), the CD is recognized as no disc.

## To Unload CDs

Take out the CD as shown below.

**1 While the CD Player is stopped, press the CD Open/Close ▲ button on the Unit to open the tray.**

**2 Remove the CD, then press the DISC SKIP button on the Unit.**

The tray turns for the next CD.

**3 Repeat step 2 to remove all the CDs.**

**4 Press the CD Open/Close ▲ button on the Unit to close the tray.**

You can remove CDs while listening to the other source.

**Tips:**

• **Removing/changing the CDs during playback**

While playing back a CD (e.g. CD1), you can remove or change the other CDs (e.g. CD2 and CD3) by pressing the CD Open/Close ▲ button. After removing or changing, press the same button to close the tray.

For MX-KB2 only

## Changing the MP3 Playback Mode

When playing an MP3 disc, you can choose the playback mode of the MP3 disc as follows:

**Normal (FILE) mode:**

The unit recognizes only tracks (files). You can play an MP3 disc like an Audio CD.

**GROUP (ALBUM) mode:**

The unit recognizes tracks (files) and albums (folders) on an MP3 disc. You can play an MP3 disc according to the way how they are grouped.

**On the remote control ONLY:**

Press MP3 before or during playing an MP3 disc.



GROUP indicator appears when the MP3 playback mode is the GROUP mode.

- Each time you press the button, the MP3 playback mode changes between "GROUP (ALBUM)" and "Normal (FILE)" alternately.



## Using the CD Player

### Basics of Using the CD Player- Normal Play

#### To Play CDs

##### 1 Load CDs.

##### 2 Press CD ►/|| button to play.

The currently selected disc number (e.g. "CD DISC 1") appears on the display.

The first track of the selected CD begins playing. When the first CD finishes playing, the next and the third CDs are continuously played back.

When the last CD has finished playing, the CD Player automatically stops.

- You can start to play the disc you want to play by simply pressing one of the Disc button (CD1-CD3).  
When the selected CD has finished playing, the CD player automatically stops.

While playing the CD, the following will appear on the display.

#### For Audio CD

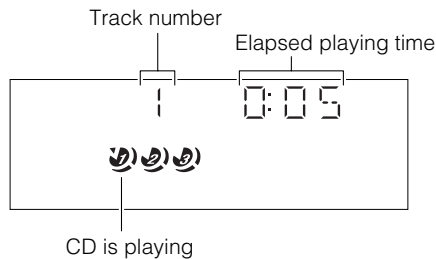

#### For MP3 disc (For MX-KB2 only)

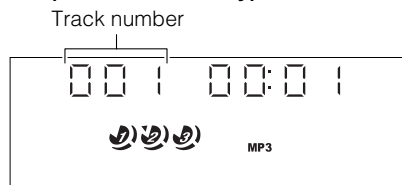

- After the display above is shown, if the tracks include ID3 tags, the display will scroll in the order of title, artist, and album, then returns to the original display.

When the Disc button (CD1-CD3) is pressed with the tray opened, the tray is closed and the selected CD automatically begins playing.

**To stop playing the CD**, press the ■ button. The following information for the CD is displayed.

#### For Audio CD

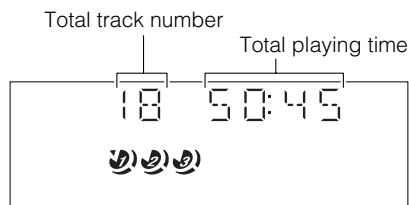

#### For MP3 disc (For MX-KB2 only)

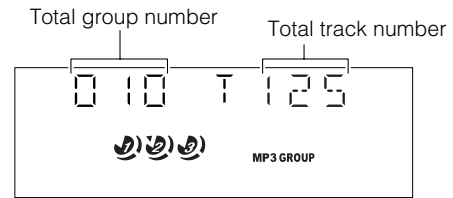

**To pause**, press the CD ►/|| button. The playing time indication blinks on the display.

**To cancel pause**, press the CD ►/|| button again. Play continues from the point where it was paused.

#### Tips:

##### • Playing back the CD using the DISC SKIP button

You can also play the CDs using the DISC SKIP button. During playback, each time you press the button, the next CD is automatically played back. If the next disc tray is empty, the disc tray is automatically skipped.

#### To Select a Track

##### During playback (using the ◀◀ or ▶▶ button):

Briefly press the ◀◀ or ▶▶ button to select the track you want to play, except for MP3 group mode.

- Press the ▶▶ button once to skip to the beginning of the next track.
- Press the ◀◀ button to skip to the beginning of the current track. Press twice quickly to skip to the beginning of the previous track.

##### In Stop mode (using the ◀◀ or ▶▶ button):

By briefly pressing the ◀◀ or ▶▶ button, the CD Player operates in the same way as during playback, except for MP3 group mode.

##### Using the numeric keys on the Remote Control:

Using the numeric keys, you can directly select the track on the currently selected CD.

- The selected track starts playing.

For example, press OVER, 1, then 5 to play back the track number 15. See "Entering the Number with the Remote Control" on page 8.

#### Tips:

##### • For MP3 discs (For MX-KB2 only)

When the selected track starts playing, information of that track scrolls on the display, in the order of file name, title, artist, and album.

#### For MX-KB2 only

#### To Select a Group (For MP3 GROUP mode only)

##### During playback (using the ◀◀ or ▶▶ button):

Briefly press the ◀◀ or ▶▶ button to select the group you want to play.

- The first track of the selected group starts playing.

##### In Stop mode (using the ◀◀ or ▶▶ button):

Briefly press the ◀◀ or ▶▶ button to select the group you want to play.

#### Search Play

Holding down the following buttons, during playback, will fast forward/backwards the CD so you can quickly find a particular passage in the track you are listening to.

- ◀◀ or ▶▶ button on the Unit
- ◀◀/◀◀ or ▶▶/▶▶ button on the Remote Control



## Programming the Playing Order of the Tracks

You can program the playing order of the tracks on all the CDs. Note that you can only make a program when the CD Player is stopped.

- You can program up to 60 tracks in any desired order including the same tracks.

### To Make a Program

#### 1 Load CDs

#### 2 In Stop mode, set the CD Player in Program Play mode.

##### On the Unit

Press the PROGRAM button, and the "PROGRAM" indicator blinks on the display.

##### On the Remote Control

Press the PROGRAM/RANDOM button, and the "PROGRAM" indicator blinks on the display.

Each time you press the button, the display changes as follows: PROGRAM → RANDOM REPEAT → Blank display (Normal Play) → (back to the beginning)

- If a program is already made, the last step of the program will be displayed.

#### 3 Press one of the Disc button (CD1-CD3) to select the CD you want to program.

The display will change to the Program Entry display.

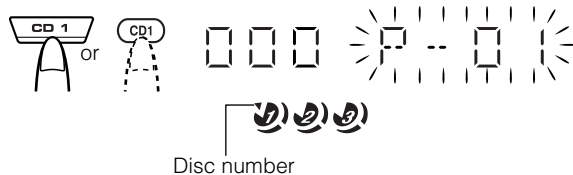

#### 4 Select the track you want to program.

##### Using the Unit

While the display is blinking, press the ◀◀ or ▶▶ button to select the track, then press the SET button.

The program order number will be assigned from P-1.

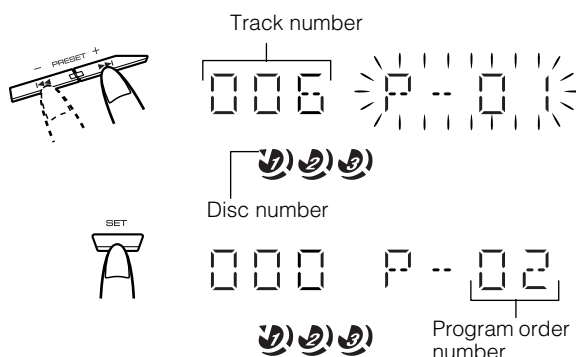

##### Using the Remote Control

Press the numeric keys to directly enter the track number. Then, the program order number will be assigned from P-1.

#### 5 Repeat steps 3 and 4 to program other tracks on the same CD or the other CD.

#### 6 To play the program, Press the CD ▶/|| button.

For details, see "To Play the Program You Have Made" mentioned below.

**To confirm the programmed contents**, while the CD player is stopped, press the SET button.

**To delete all the tracks in the program**, while the CD Player is stopped, press the CANCEL button.

#### Notes

- If you try to program a track number that does not exist on the CD, your entry will be ignored.
- If you try to program the 61st track, "FULL" appears on the display.

### To Play the Program You Have Made

Press the CD ▶/|| button.

The System plays the tracks in the order you have programmed them.

- To use Repeat Play for Program Play, press the REPEAT button to select "ALL" or "1" before starting playback. For details, see "Repeating Tracks" on page 15.

- You can skip to a particular program track by pressing the ◀◀ or ▶▶ button during Program Play.

- To stop playing, press the ■ button once.

### To Exit and Re-enter Program Play

The program you have made is stored in memory. So, you can exit Program Play temporarily or re-enter Program Play unless you delete the program.

**To exit the program mode once**, while the CD Player is stopped, press the PROGRAM button on the Unit or the PROGRAM/RANDOM button on the Remote Control to light off the "PROGRAM" indicator. By changing the source to the other (e.g. Tuner), the CD Player also exits Program Play mode.

**To re-enter Program Play mode**, press the PROGRAM or PROGRAM/RANDOM button until the "PROGRAM" indicator blinks again.

#### Note

- Even when the power is turned off (standby mode), the programmed tracks are not deleted. So, you can re-enter Program Play mode.

## Using the CD Player

### Random Play

The tracks of the selected CD will play in no special order when you use this mode.

#### 1 In Stop mode, set the CD Player in Random Play mode.

##### On the Unit

Press the RANDOM button to light the "RANDOM", "REPEAT" and "1 CD" indicator.

##### On the Remote Control

Press the PROGRAM/RANDOM button until the "RANDOM" indicator lights up.

The "REPEAT" and "1 CD" indicator also light up on the display. Each time you press the button, the display changes as follows: PROGRAM → RANDOM REPEAT → Normal display (Normal Play) → (back to the beginning)

#### 2 Press the CD ►/|| button.

The tracks on all the CDs are played in random order.

**To stop playing**, press the ■ button.

**To skip a track during playback**, press the ►►| button to jump to the next track in the random sequence.

**To exit Random Play mode**, while the CD Player is stopped, press the RANDOM button on the Unit or the PROGRAM/RANDOM button on the Remote Control again to light off the "RANDOM" indicator.

### Repeating Tracks

You can repeat all tracks or individual track, as many times as you like.

#### Press the REPEAT button.

The Repeat indicator changes with each press of the button, as follows:

ALL CD → 1CD → 1 → Blank display → (back to the beginning)

**REPEAT ALL:** In Normal Play mode, repeats all the tracks on all the CDs.

In Program Play mode, repeats all the tracks in the program.

**REPEAT 1CD:** Repeats all tracks on one CD. (Selectable in Normal Play only)

**REPEAT 1:** Repeats one track.

**To stop playing**, press the ■ button. Changing the source to the other (e.g. Tuner) will also stop playing.

**To exit Repeat mode**, press the REPEAT button until the "REPEAT" indicator on the display goes out.

### Tray Lock Function

In order to safely keep the CD in the CD Player, the tray can be electronically locked.

#### Locking the Tray

##### 1 Turn on the System and enter CD mode.

##### 2 While pressing down the ■ button, press the CD Open/Close ▲ button on the Unit.

"LOCKED" appears on the display.

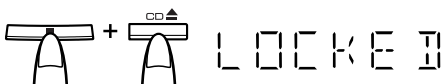

- If you try to open the tray by pressing the ▲ button, "LOCKED" appears on the display to let you know that the tray has been locked.

#### Unlocking the Tray

Repeat above steps 1 and 2.

"UNLOCKED" appears on the display.



- Even after the System is unplugged, the tray lock condition will be retained for a few days.

### Changing the Display for CD

Each time you press the DISPLAY button, the display changes as follows:

Track number, elapsed playing time of the track



Track number, remaining time of the track



Track number, remaining time of the disc



Track number, elapsed playing time of the disc



Clock



(back to the beginning)

#### For MP3 discs (For MX-KB2 only)

Track number, elapsed playing time of the track



ID3 tag

The display scrolls in order of title, artist and album



Album/file name (maximum 16 characters)

The display scrolls in order of album and file name



Group number, track number



Clock



(back to the beginning)

# Using the Cassette Deck (Listening to a Tape)

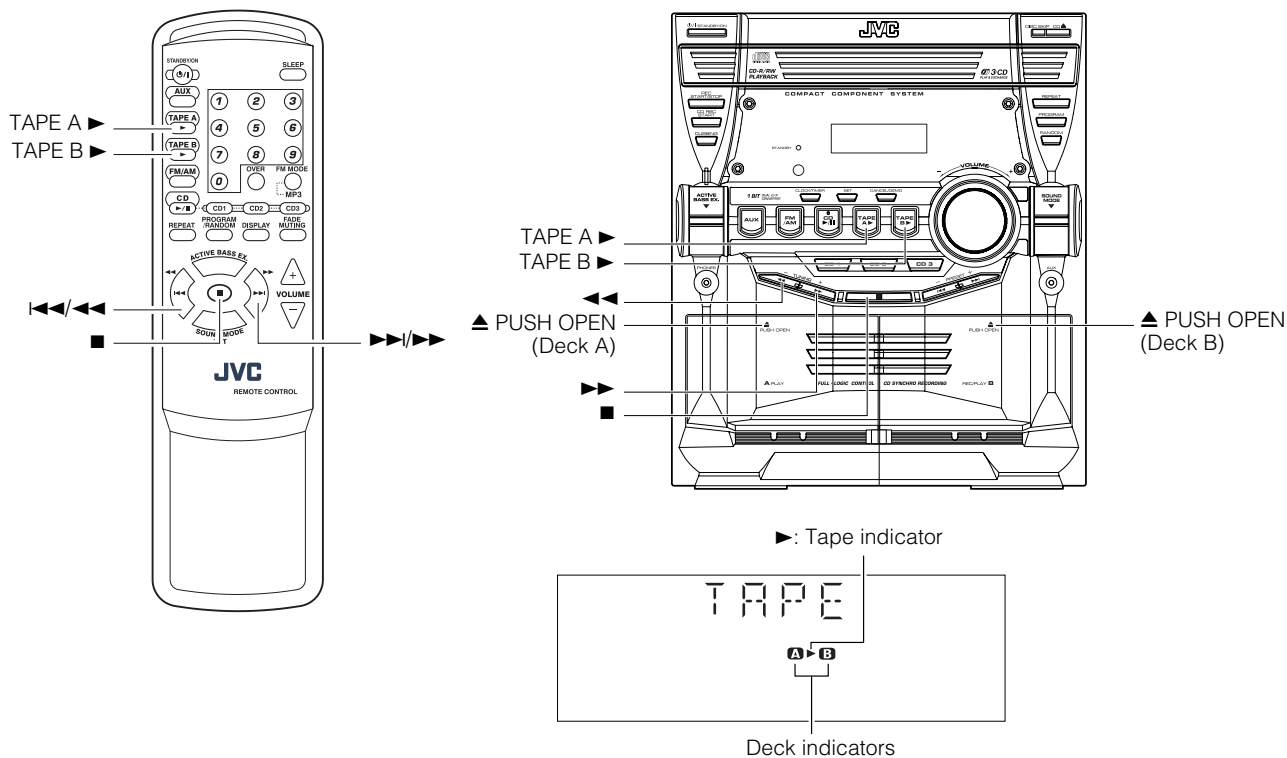

\* When the System is in use, the display shows other items as well. For simplicity, we show here only the items described in this section.

The Cassette Deck allows you to play, record, and dub audio tapes.

☐ Listening to type I tape is suitable for this Cassette Deck.

**The use of tapes longer than 120 minutes (including 120 minute tapes) is not recommended, since characteristic deterioration may occur and these tapes easily jam in the pinch-rollers and the capstans.**

## One Touch Play

By pressing the TAPE A ▶ or TAPE B ▶ button, the System will come on, and if a tape is in the deck, it will start to play. If no tape is loaded, the operation is ignored.

## Playing a Tape

You can use either Deck A or Deck B at a time for playback.

**1 Press the ▲ PUSH OPEN part for the deck you want to use.**

**2 When the cassette holder opens, put a cassette in, with the exposed part of the tape down, toward the base of the Unit.**

The tape will travel from the left to right.

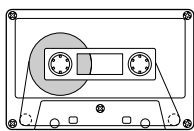

Tape travelling direction

- If the cassette holder does not open, turn the System off, then back on and press the ▲ PUSH OPEN part again.

## 3 Close the cassette holder gently.

When both Deck A and Deck B contain a tape, the last deck to have a tape inserted is selected.

## 4 Press the TAPE A ▶ or TAPE B ▶ button.

The selected Deck appears (for example, TAPE-A) and the Deck indicator "A" or "B" lights up on the display. The Tape indicator (▶) lights up on the display and the tape is played back.

The Cassette Deck automatically stops when one side of the tape has finished playing.

**To stop playing,** press the ■ button.

**To remove the tape,** stop the tape, and press the ▲ PUSH OPEN part to open the Cassette Holder.

## To Fast-Wind a Tape

During playback or in Stop mode, press the ▶▶ (FF) button on the Unit to fast-wind the tape onto the right side of the cassette without playing. (You can also use the ▶▶/▶▶ button on the Remote Control.)

During playback or in Stop mode, press the ◀◀ (REW) button on the Unit to fast-wind the tape onto the left side of the cassette without playing. (You can also use the ◀◀/◀◀ button on the Remote Control.)

- The Cassette Deck automatically stops when one side of the tape has finished playing.

☐ During fast-winding the tape, you can change the tape travelling direction by pressing the ▶▶ (FF) or ◀◀ (REW) button.

# Using the Cassette Deck (Recording)

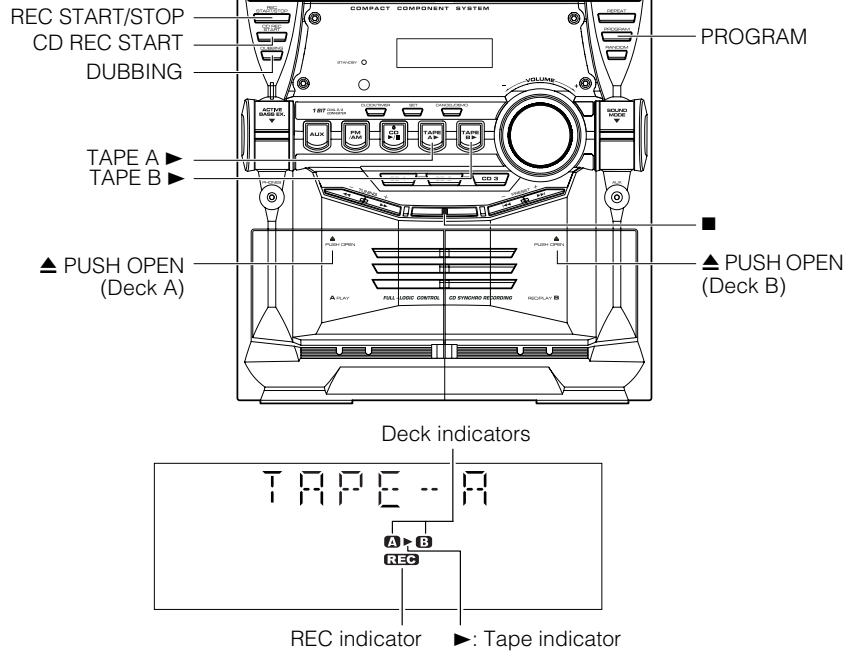
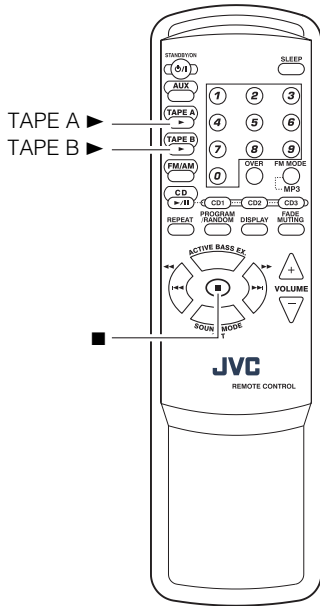

\* When the System is in use, the display shows other items as well.  
For simplicity, we show here only the items described in this section.

Recording onto a cassette from any of the sound sources is simple. Just place a tape in Deck B, have the source ready, make one or two settings, and you're ready to record. For each source, the procedure is a little bit different so we explain each separately. But first, here are a few things to make your recordings better.

## Things To Know Before You Start Recording

- ❑ It may be unlawful to record or playback copyright material without the consent of the copyright owner.
- ❑ The recording level, which is the volume at which the new tape is being made, is automatically set correctly, so it is not affected by the VOLUME Control on the System. Also, it is not affected by adjusting the sound effects. Thus, during recording, you can adjust the sound you are actually listening to without affecting the recording level.
- ❑ Two small tabs on the back of the cassette tape, one for side A and one for side B, can be removed to prevent accidental erasure or recording.

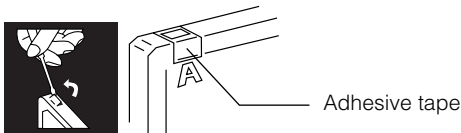

- ❑ To record on a cassette with the tabs removed, you must cover the holes with adhesive tape first.
- ❑ Type I tape can be used for recording.

### Note

- At the start and end of cassette tapes, there is leader tape which cannot be recorded onto. Thus, when recording CDs, radio broadcasts, etc., wind on the leader tape first to ensure getting the beginning of the recording.

## CAUTION:

- If a recording you make has excessive noise or static, the Unit may have been too close to a TV which was on during the recording. Either turn off the TV or increase the distance between the TV and the Unit.

## Standard Recording

This is the basic method for recording any source. The System also has special ways for recording CD to tape, and tape to tape, which save you time and effort, as well as give you some special effects. However, when you need to add a selection to a tape you have made, or are combining selections from several sources on one tape, use the method described below; just substitute the source you want into this procedure, such as a tape in Deck A, a CD, or the Tuner. You can also record from an external equipment with this procedure.

### To Record Any Sound Source to Tape

Follow these steps to record from any sound source onto a tape in Deck B.

#### 1 Insert a blank or erasable tape into the Deck B and wind past the tape leader.

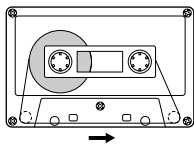

Tape travelling direction

#### 2 Prepare the source, by, for example, tuning in a radio station, loading CDs, or turning on connected equipment.

- For CD recording, see “CD Synchro Recording” mentioned below.
- For dubbing, see “Tape to Tape Recording (Dubbing)” described below.

#### 3 Press the REC START/STOP button on the Unit.

The “REC” indicator and the Tape indicator (▶) light up and the System begins recording.

- If the tab of the cassette tape on the Deck B is removed to prevent erasure or recording, “PROTECT” will appear on the display.

**To stop during recording**, press the REC START/STOP button on the Unit, or press the ■ button.

### Recording an AM Station to Tape (Beat Cut)

When recording an AM broadcast, beats may be produced which are not heard when listening to the broadcast. If this happens, press the FM MODE button on the Remote Control to eliminate the beats.

#### 1 Set to AM station and start recording.

#### 2 Press the FM MODE button on the Remote Control to eliminate the beats.

Each time you press the button, the display changes as shown below:

CUT 1 ↔ CUT 2

## CD Synchro Recording

Everything on the CD goes onto the tape in the order it is on the CD, or according to the order you have set in a program.

#### 1 Prepare CDs. (See page 12.)

Press the CD1-3 button (that you want to make recording), and then press the ■ button.

- If you want to record specific tracks only, you need to program the tracks beforehand. (See page 14.)
- If you want to record one CD only, you need to load one CD only.

#### 2 Insert a blank or erasable tape into the Deck B and wind past the tape leader.

#### 3 Press the CD REC START button on the Unit.

“CD REC” appears on the display and the “REC” indicator lights up. Then, the System begins CD Synchro Recording and the tracks on the CD are recorded on the tape.

- When recording of the tracks of all CDs is finished, the CD Player and Cassette Deck stop.
- If the tab of the cassette tape on the Deck B is removed to prevent erasure or recording, “PROTECT” will appear on the display.
- After the CD Player has played the entire CD or all the programmed tracks, the tape automatically stops.

**To stop at any time during the recording process**, press the ■ button. The CD Player will be paused and the Cassette Deck will be stopped. Press the ■ button again, the CD player will be stopped.



- When making SLEEP timer settings while doing CD Synchro recording, set enough time to allow for the CD to finish playing, otherwise the power will go off before recording is completed.

## Tape to Tape Recording (DUBBING)

Recording from one tape to another is called dubbing. You can dub tapes simply, with just a single button.

#### 1 Insert the source cassette you want to copy from into Deck A for playback.

#### 2 Press the TAPE A ▶ button, and then press the ■ button.

#### 3 Insert a blank or erasable cassette you want to copy onto into Deck B for recording.

#### 4 Press the DUBBING button on the Unit.

Deck A and Deck B will start simultaneously, “DUBBING” appears and the “REC” indicator lights up.

During dubbing, the Deck indicators “A” and “B” light up alternately.

- If no tape is inserted into Deck A, the DUBBING button will not work.
- If no tape is inserted into Deck B, “NO TAPE” will appear on the display.

**To stop dubbing**, press the REC START/STOP button on the Unit or the ■ button.



- During dubbing, you can hear sound effects through the speakers or headphones. However, the sound is dubbed without sound effects.

# Using an External Equipment

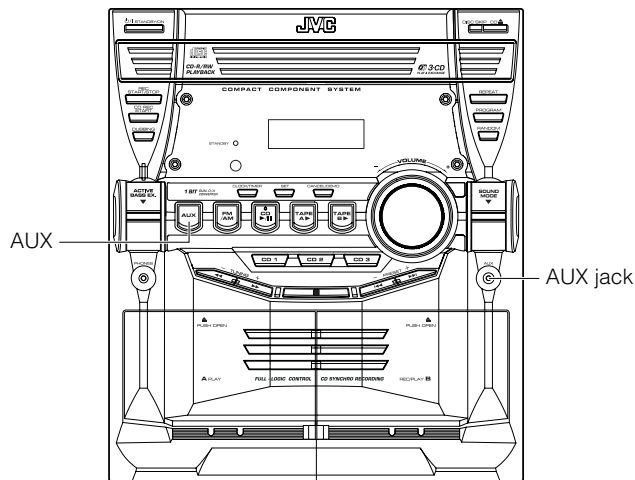
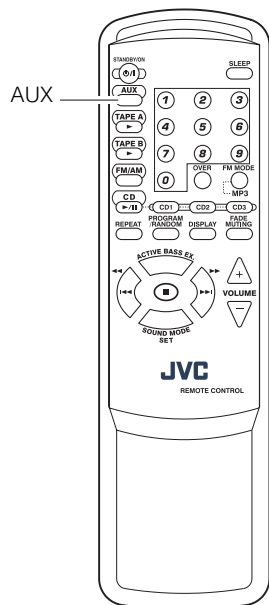

## Listening to the External Equipment

You can listen to the external equipment such as MD recorder, cassette deck, or other auxiliary.

- First, make sure that the external equipment is properly connected to the System. (See page 6.)

**1 Set the volume level to the minimum position.**

**2 Press the AUX button.**

“AUX” appears on the display.

AUX

**3 Start playing the external equipment.**

**4 Adjust the volume level to the level you want listen to.**

**5 Apply the following sound effects, if you wish.**

- ACTIVE BASS EX. (See page 8.)
- Sound Mode (See page 8.)

**To exit AUX mode,** select other source (e.g. Tuner).



- For operation of the external equipment, refer to its Instructions.



# Using the Timers

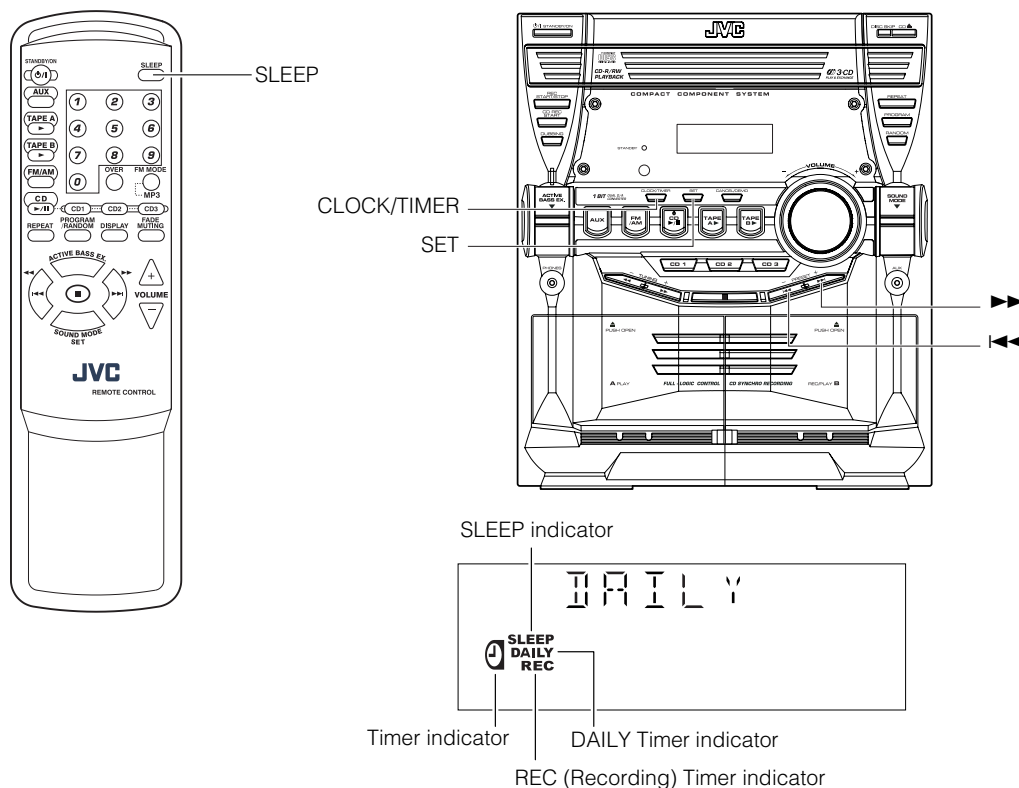

\* When the System is in use, the display shows other items as well. For simplicity, we show here only the items described in this section.

Three types of timers are available:

### DAILY Timer

Use this timer to set wake up everyday to music from any source, instead of an alarm clock.

### REC (Recording) Timer

Unattended recording of radio broadcasts. You can set the starting time and ending time.

### SLEEP Timer

Fall asleep and have your System turn off automatically after a certain length of time.

## Setting the Clock

When you plug the AC power cord into the wall outlet, the time indication "0:00" blinks on the display.

You can set the clock whether the System is on or off.

### Using the Unit

#### 1 Press the CLOCK/TIMER button.

The hour digit of the time indication blinks on the display.

#### 2 Press the ◀◀◀ or ▶▶▶ button to set the hour.

Pressing the ▶▶▶ button moves the time forwards and pressing the ◀◀◀ button moves it backwards. Holding down the button moves the hour rapidly.

#### 3 Press the SET button.

The minute digits of the time indication blink on the display.

- To return to the hour setting, press the CANCEL button.

#### 4 Press the ◀◀◀ or ▶▶▶ button to set the minute.

#### 5 Press the SET button.

"CLOCK OK" appears on the display. Then, the selected time is set and the seconds start counting from 0.

## Fixing the Clock

### Using the Unit

#### 1 Press the ⏻/⏻ STANDBY/ON button to turn on the System.

#### 2 Press the CLOCK/TIMER button repeatedly until clock setting display (time indication) appears on the display.

The hour digits of the current clock blink on the display.

Each time you press the button, display changes as follows:  
DAILY → ON TIME → REC TU → ON TIME → Clock Setting display (time indicator) → Canceled → (back to the beginning)

#### 3 Follow steps 2 to 5 of "Setting the Clock" mentioned above.

### Notes

- The clock must be correctly set for the timers to work.
- The clock may gain or lose one to two minutes per month.
- If there is a power failure, the clock loses its setting immediately. "0:00" blinks on the display and the clock must be reset.

## Using the Timers

### Setting the Daily Timer

Once you have set the Daily Timer, the timer will be activated at the same time every day.

The Timer indicator (🕒) and “DAILY” indicator on the display shows that the Daily Timer you have set is in effect.

You can set the Daily Timer whether the System is turned on or off.

#### Notes

- You can set the Daily Timer whether the System is on or off.
- Perform each setting within approx. 8 seconds. Otherwise, setting will be cleared and the procedure must be repeated from the beginning.
- If you have made a mistake while setting the timer, press the CANCEL button on the Unit. However, this does not always cancel the current setting. If the CANCEL button does not work, press the CLOCK/TIMER button on the Unit repeatedly until the display returns to the original display, and start from the first step.

### Using the Unit

#### 1 Press the CLOCK/TIMER button until “ON TIME” immediately after “DAILY” appears on the display.

Each time you press the button, the display changes as follows:  
DAILY → ON TIME\* → REC TU → ON TIME → Clock setting display → Canceled → (back to the beginning)

\*: This item should be selected for the Daily Timer setting.

Then, the System enters ON-time setting mode, and the current ON time appears on the display and the hour digits, “DAILY” and the Timer (🕒) indicator blink.

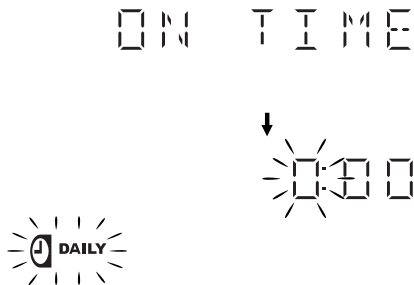

#### 2 Setting the ON time (Example: 10:15).

1. Press the ►► or ◄◄ button to set the hour you want the System to come on, then press the SET button. The minute digits of the ON time blink on the display. Pressing the ►► button moves the time forwards and pressing the ◄◄ button moves it backwards. Holding down the button moves the time rapidly.



2. Press the ►► or ◄◄ button to set the minute, then press the SET button.

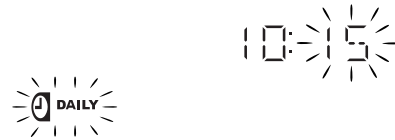

“OFF TIME” appears and then the System enters OFF-time setting mode. The current OFF time appears on the display, and the hour digits blink.

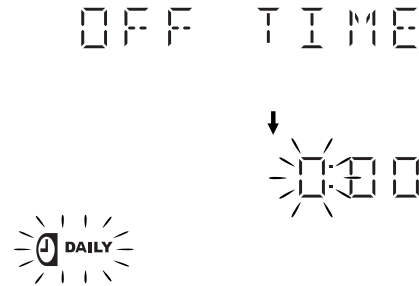

#### 3 Setting the OFF time (Example: 13:15).

1. Press the ►► or ◄◄ button to set the hour you want the System to be turned off, then press the SET button. The minute digits of the OFF time blink on the display.



2. Press the ►► or ◄◄ button to set the minute, then press the SET button.



The System enter Music Source Selecting mode and “TUNER FM” appears on the display.



#### 4 Selecting the music source.

- Press the ►► or ◄◄ button to select the music source you want to listen to, then press the SET button. Each time you press the ►► or ◄◄ button, the display changes as shown below:  
TUNER FM → TUNER AM → CD → TAPE → AUX → (back to the beginning)  
According to the music source you have selected, the next operation differs.

- TUNER FM:** Tunes in to the specified preset FM station.  
**TUNER AM:** Tunes in to the specified preset AM station.  
**CD:** Plays the specified track on the specified CD.  
**TAPE:** Plays a tape last inserted.  
**AUX:** Plays an external source.



**Preparation for each music source:**

Perform the following operation according to the music source you have selected. Then, the System enters Volume Setting mode.

**When selecting TUNER FM or TUNER AM:**

Press the ►► or ◀◀ button to select the preset station number, then press the SET button.

**When selecting CD :**

Press the ►► or ◀◀ button to select the disc number, then press the SET button.

Each time you press the button the disc number changes as follows:

DISC 1 → DISC 2 → DISC 3 → (back to the beginning)

**When selecting TAPE:**

Insert a cassette tape you want to play into Deck A.

**When selecting AUX:**

Prepare the external equipment so that it will turn on at the ON time set by the System.

To allow this, the equipment should have the timer function.

**5 Setting the volume level.**

Press the ►► or ◀◀ button to select the volume level.

**MIN, 1-30, or MAX:** When the timer is turned on, the Volume will be automatically set to the selected level.

**6 Press the SET button.**

The timer setting is completed, and “SET OK” appears on the display. Then the display returns to the display before you set the Timer.

**7 Press the ⏻/| STANDBY/ON button to turn off the System if necessary.**

The Timer indicator (⌚) and “DAILY” indicator are lit on the display, showing that the Daily Timer is set to on.

**To confirm / change the timer setting,** repeat the setting procedure from the beginning.

**When the timer ON-time comes:**

The following operation will be automatically repeated every day.

- When the timer ON-time comes, and the System automatically turns on. The music source you have set is played. The Timer indicator (⌚) and “DAILY” indicator blink during timer operation.
- When the timer OFF-time comes, the System automatically turns off. Then, the Timer indicator (⌚) and “DAILY” indicator remain lit on the display.



- If the System is already on when the timer ON-time comes, the Daily Timer does not work.

**Turning the Daily Timer On and Off**

Once you have set the Daily Timer, it is stored in memory. So, the Daily Timer will be activated at the same time every day until it is canceled.

**To cancel the Daily Timer temporarily:**

**1 Press the CLOCK/TIMER button on the Unit repeatedly until the “DAILY” appears on the display.**

**2 Press the CANCEL button on the Unit.**

“CANCEL” appears and both the Timer indicator (⌚) and the “DAILY” indicator go out.

**To activate the cancelled Daily Timer:**

**1 Press the CLOCK/TIMER button on the Unit repeatedly until the “DAILY” appears on the display.**

The “DAILY” indicator and the Timer indicator (⌚) blink on the display.

**2 Press the SET button on the Unit.**

“SET OK” appears on the display. The Timer indicator (⌚) and the “DAILY” indicator remain lit, and the display returns to the original display.



- If the System is unplugged, or a power failure occurs, the timer setting will be lost in a few days. You will need to reset the clock first, then the timer.

**Setting the REC (Recording) Timer**

With the Recording Timer, you can make a tape of a radio broadcast automatically whether or not you are home.



- You can set the REC Timer whether the System is on or off.
- The volume level is automatically set to MIN when REC Timer is used.
- Perform each setting within approx. 8 seconds. Otherwise, setting will be cleared and the procedure must be repeated from the beginning.
- If you have made a mistake while setting the timer, press the CANCEL button on the Unit. However, this does not always cancel the current setting. If the CANCEL button does not work, press the CLOCK/TIMER button on the Unit repeatedly until the display returns to the original display, and start from the first step.

## Using the Timers

### Using the Unit

You can set the time in the same way as for setting the Daily Timer.

#### 1 Insert a blank or erasable tape into the Deck B and wind past the tape leader.

#### 2 Press the CLOCK/TIMER button until “ON TIME” immediately after “REC TU” appears on the display.



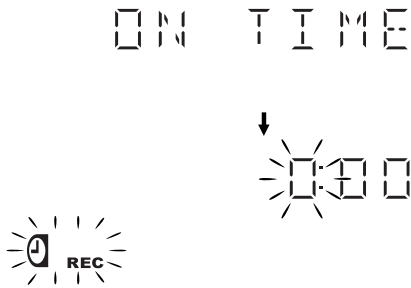

Each time you press the button, the display changes as follows: DAILY → ON TIME → REC TU → ON TIME\* → Clock setting display → Canceled → (back to the beginning)

\*: This item should be selected for the REC Timer setting.

Then, the System enters ON-time setting mode. The current ON time appears on the display and the hour digits, “REC” indicator and the timer indicator (  ) blink.







#### 3 Setting the ON time you want the System to turn on.

1. Press the  or  button to set the hour, then press the SET button.
2. Press the  or  button to set the minute, then press the SET button.





“OFF TIME” appears and then the System enters OFF-time setting mode. The current OFF time appears on the display, and the hour digits blink.

#### 4 Setting the OFF time you want the System to turn off.

1. Press the  or  button to set the hour, then press the SET button.
2. Press the  or  button to set the minute, then press the SET button.

The System enters Preset Station Entering mode.

#### 5 Select the preset station for recording.



1. Press the  or  button to set the band (TUNER FM or TUNER AM), then press the SET button.
2. Press the  or  button to set the preset number, then press the SET button.

“SET OK” appears on the display. The “REC” indicator stops blinking and remains lit.

#### 6 Press the STANDBY/ON button to turn off the System, if necessary.

To confirm / change the timer setting, repeat the setting procedure from the beginning.

#### When the timer ON-time comes:

- When the timer ON-time comes, the System automatically turns on. The station you have set is played. The Timer indicator (  ) blinks during timer operation. To stop timer recording, press the  button.
- When the timer OFF-time comes, the System automatically turns off.

#### Note

- If the System is already on when the timer ON-time comes, the REC Timer does not work.

### Turning the REC (Recording) Timer On and Off

Once you have set the REC Timer to record a source, the timer setting is stored in memory. So, though the REC Timer turns off once it is used, you can recall it at any time.

#### To cancel the REC Timer temporarily:

#### 1 Press the CLOCK/TIMER button on the Unit repeatedly until “REC TU” appears on the display.

#### 2 Press the CANCEL button on the Unit.

“CANCEL” appears and both the Timer indicator (  ) and the “REC” indicator go out.

#### To activate the cancelled REC Timer:

#### 1 Press the CLOCK/TIMER button on the Unit repeatedly until “REC TU” appears on the display.

The Timer indicator (  ) and the “REC” indicator blink on the display.

#### 2 Press the SET button on the Unit.

“SET OK” appears on the display. The Timer indicator (  ) and the “REC” indicator remain lit, and the display returns to the original display.

#### Note

- If the System is unplugged, or a power failure occurs, the timer setting will be lost in a few days. You will need to reset the clock first, then the timer.

## Setting the SLEEP Timer

Use the Sleep Timer to turn the System off after a certain number of minutes when it is playing. By setting the Sleep Timer, you can fall asleep to music and know that your System will turn off by itself rather than play all night.

- You can only set the Sleep Timer when the System is on.

### Using the Remote Control

#### 1 During playback a source, press the SLEEP button.

The "SLEEP" indicator starts blinking on the display.

#### 2 Set the length of time you want the source to play before shutting off.

Each time you press the SLEEP button, the time length changes as follows:

10 → 20 → 30 → 60 → 90 → 120 → OFF → (back to the beginning)



60

#### 3 Wait for 5 seconds.

The "SLEEP" indicator stops blinking and remains lit, and the display returns to the original one before setting the Sleep Timer.

The System is now set to turn off after the number of minutes you have set.

#### To Confirm the Sleep Time:

When the SLEEP button on the Remote Control is pressed, the remaining sleep time is displayed. Wait until the display returns to the original display.

#### To Cancel the SLEEP Timer Setting:

Press the SLEEP button on the Remote Control until the "SLEEP" indicator goes out on the display.

- Turning off the System also cancels the SLEEP Timer.

## Timer Priority

Since REC Timer and DAILY Timer can be set independently, you may wonder what happens if the settings overlap. Here are the priorities for REC Timer and DAILY Timer:

- Timer with the earlier time setting will have the priority. Timer will not operate when other Timer is operating.
  - If other Timer is set to an exact same time as the REC Timer, the REC Timer will have the priority.
- REC Timer and DAILY Timer will not operate when SLEEP Timer is operating.

### Example

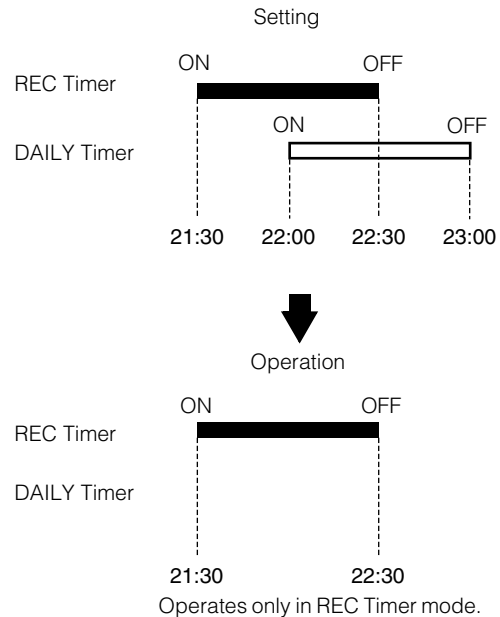

# Care And Maintenance

Handle your CDs and tapes carefully, and they will last a long time.

## Compact Discs



- Only CDs bearing these marks can be used with this System. However, continued use of irregular shape CDs (heart-shape, octagonal, etc.) can damage the System.

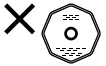
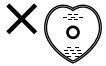

- Remove the CD from its case by holding it at the edges while pressing the case's center hole lightly.
- Do not touch the shiny surface of the CD, or bend the CD.



- Put the CD back in its case after use to prevent warping.
- Be careful not to scratch the surface of the CD when placing it back in the case.
- Avoid exposure to direct sunlight, temperature extremes, and moisture.



- A dirty CD may not play correctly. If a CD does become dirty, wipe it with a soft cloth in a straight line from center to edge.



### **CAUTION:**

- Do not use any solvent (for example, conventional record cleaner, spray thinner, benzene, etc.) to clean a CD.

## General Notes

In general, you will have the best performance by keeping your CDs and the mechanism clean.

- Store CDs in their cases, and keep them in cabinets or on shelves.
- Keep the System's Top Cover closed when not in use.

## Moisture Condensation

Moisture may condense on the lens inside the System in the following cases:

- After turning on heating in the room.
- In a damp room.
- If the System is brought directly from a cold to a warm place.

Should this occur, the System may malfunction. In this case, leave the System turned on for a few hours until the moisture evaporates, unplug the AC power cord, and then plug it in again.

## Cassette Tapes

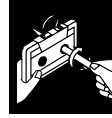

- If the tape is loose in its cassette, take up the slack by inserting a pencil in one of the reels and rotating.
- If the tape is loose, it may get stretched, cut, or caught in the cassette.



- Do not touch the tape surface.



- Do not store the tape:
  - In dusty places
  - In direct sunlight or heat
  - In moist areas
  - On a TV or speaker
  - Near a magnet

## Cassette Deck

- If the heads, capstans, and pinch-rollers of the Cassette Deck become dirty, the following will occur:
  - Loss of sound quality
  - Discontinuous sound
  - Fading
  - Incomplete erasure
  - Difficulty recording
- Clean the heads, capstans, and pinch-rollers using a cotton swab moistened with alcohol.

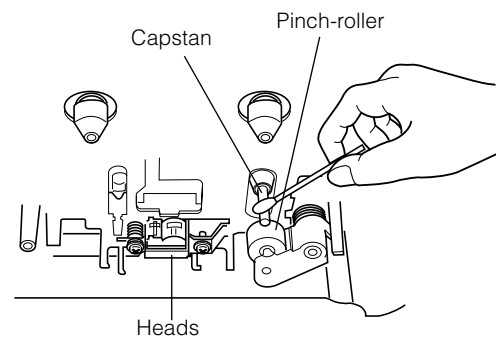

- If the heads become magnetized, the Unit will produce noise or lose high frequencies.
- To demagnetize the heads, turn off the Unit, and use a head demagnetizer (available at electronics and record shops).

# Troubleshooting

- If you are having a problem with your System, check this list for a possible solution before calling for service.
- If you cannot solve the problem from the hints given here, or the System has been physically damaged, call a qualified person, such as your dealer, for service.

Symptom	Possible Cause	Action
No sound is heard.	<ul style="list-style-type: none"> <li>• Connections are incorrect, or loose.</li> <li>• Headphones are connected.</li> </ul>	<ul style="list-style-type: none"> <li>• Check all connections and make corrections. (See pages 4 to 6.)</li> <li>• Disconnect the headphones.</li> </ul>
Poor radio reception	<ul style="list-style-type: none"> <li>• The antenna is disconnected.</li> <li>• The AM Loop Antenna is too close to the System.</li> <li>• The FM Wire Antenna is not properly extended and positioned.</li> </ul>	<ul style="list-style-type: none"> <li>• Reconnect the antenna securely.</li> <li>• Change the position and direction of the AM Loop Antenna.</li> <li>• Extend FM Wire Antenna to the best reception position.</li> </ul>
The disc tray does not open.	<ul style="list-style-type: none"> <li>• The AC power cord is not plugged in.</li> <li>• Tray is locked.</li> </ul>	<ul style="list-style-type: none"> <li>• Plug the AC power cord.</li> <li>• Unlock the tray. (See page 15.)</li> </ul>
The CD skips.	The CD is dirty or scratched.	Clean or replace the CD. (See page 25.)
The CD does not play.	The CD is upside down.	Put the CD in with the label side up.
The MP3 disc does not play. (For MX-KB2 only)	<ul style="list-style-type: none"> <li>• No MP3 files are recorded on the disc.</li> <li>• MP3 files do not have the file extension — .MP3, .Mp3, .mP3, or .mp3 in their file names.</li> <li>• MP3 files are not recorded in the format compliant with ISO 9660 Level 1 or Level 2.</li> </ul>	Replace the disc.
The readout time of the MP3 disc is too long. (For MX-KB2 only)	The readout time varies with the complexity of the recording configuration.	Do not use too many hierarchies and folders when recording. Also, do not record any other types of audio tracks together with MP3 files. (See page 11.)
The cassette holder cannot be opened.	During tape playing, the power cord was unplugged.	Plug in the power cord, and turn on the System.
Unable to record.	Cassette record protect tabs are removed.	Cover holes on back edge of cassette with tape.
Unable to operate the Remote Control.	<ul style="list-style-type: none"> <li>• The path between the Remote Control and the sensor on the Unit is blocked.</li> <li>• The batteries have lost their charge.</li> </ul>	<ul style="list-style-type: none"> <li>• Remove the obstruction.</li> <li>• Replace the batteries.</li> </ul>
Operations are disabled.	The built-in microprocessor has malfunctioned due to external electrical interference.	Unplug the System then plug it back in.

# Specification

<b>Amplifier</b>	
Output Power	30 W per channel, min. RMS, driven into 6 Ω at 1kHz, with no more than 10% total harmonic distortion (IEC 268-3)
<b>Input Sensitivity/Impedance (1 kHz)</b>	
AUX IN	500 mV/51 kΩ
Speaker terminals	6 - 16 Ω
Phones	32 Ω - 1 kΩ
	20 mW/ch output into 32 Ω
<b>Cassette Deck Section</b>	
Frequency Response	
Type I (NORMAL)	63 Hz - 12 500 Hz
Wow And Flutter	0.15% (WRMS)
<b>CD Player</b>	
CD Capacity	3 CDs
Dynamic Range	85 dB
Signal-To-Noise Ratio	85 dB
Wow And Flutter	Unmeasurable
<b>Tuner</b>	
FM Tuner	
Tuning Range	87.5 - 108.0 MHz
AM Tuner	
Tuning Range	530 kHz - 1710 kHz (at AM10 kHz channel space) 531 kHz - 1710 kHz (at AM9 kHz channel space)
<b>Unit</b>	
Dimensions	276 mm × 315 mm × 456 mm (W/H/D)
Mass	Approx. 8 kg

## Speaker Specifications (each unit)

SP-MXKB2/SP-MXKB1	
Type	2-way bass-reflex type
Speaker Unit	Woofer: 13 cm cone × 1 Tweeter: 5 cm cone × 1
Power Handling Capacity	30 W
Impedance	6 Ω
Frequency Range	65 Hz - 20,000 Hz
Sound pressure level	86 dB/W·m
Dimensions	208 mm × 323 mm × 264 mm (W/H/D)
Mass	Approx. 3 kg

## Accessories

AM Loop Antenna (1)  
Remote Control (1)  
Batteries R03 (UM-4)/AAA (24F) (2)  
FM Wire Antenna (1)  
AC Plug Adaptor (1)

## Power Specifications

Power Requirements	AC 110/127/220/230-240V ~, adjustable with voltage selector, 50/60 Hz
Power Consumption	83 W (power on mode) 13 W (in Standby mode)

*Design and specifications are subject to change without notice.*

**Mains (AC) Line Instruction (not applicable for Europe, U.S.A., Canada, Australia, and U.K.)**

**Instrucción sobre la línea de la red (CA) (no aplicable para Europa, EE.UU., Canadá, Australia, ni el Grã-Bretanha)**

**Instrução sobre a tensão da rede eléctrica (CA) (não aplicável para a Europa, os E.U.A., o Canadá, a Austrália e o Reino Unido)**

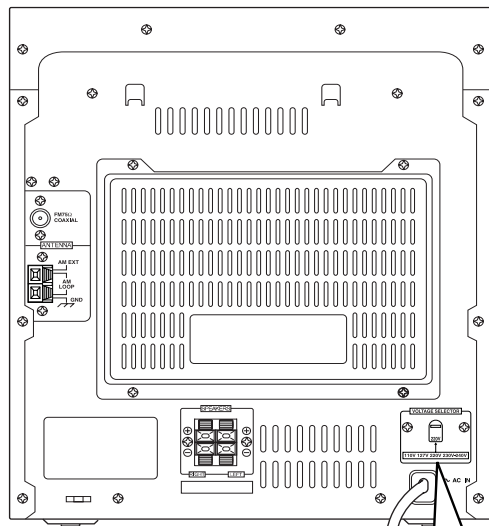

**IMPORTANT for mains (AC) line**

BEFORE PLUGGING IN, do check that your mains (AC) line voltage corresponds with the position of the voltage selector switch provided on the outside of this equipment and, if different, reset the voltage selector switch, to prevent from a damage or risk of fire/electric shock.

**IMPORTANTE para la línea de la red (CA)**

ANTES DE ENCHUFAR EL EQUIPO, compruebe si la tensión de la línea de la red (CA) corresponde con la posición del selector de tensión situado en la parte exterior del equipo, y si es diferente, reajuste el selector de tensión para evitar el riesgo de incendios/descargas eléctricas.

**IMPORTANTE para a ligação à tensão da rede (CA)**

ANTES DE LIGAR O APARELHO A UMA TOMADA DA REDE, verifique se a tensão da rede CA corresponde à posição do seletor de voltagem localizado na parte externa deste equipamento. Caso não corresponda, reajuste o seletor de voltagem a fim de evitar avarias ou riscos de incêndio e choque elétrico.

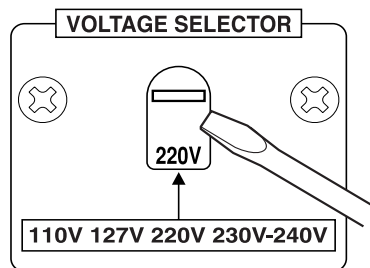

**JVC**